

Deep Cycle VRLA AGM Battery

VTD12-100

The Valiant VTD series deep cycle AGM battery features special additives to the positive plate and advanced AGM separators which increase cycle life up to 70% higher compared with standard AGM batteries. This technology also provides up to 15 years of float life. The VTD series is highly suited for systems that rely heavily on battery storage power such as off-grid solar systems, RV and marine and electric vehicles.

12V Voltage	100Ah Capacity	AGM Technology	Deep Cycle
-----------------------	--------------------------	--------------------------	----------------------



COMPLIED STANDARDS

IEC 60896-21/22	JIS C8704
YD/T799	ISO9001
GB/T 19638	CE

GENERAL FEATURES

- Thicker plate with high Tin low Calcium alloy
- Deep discharge recovery, 1200cycle @ 50% DOD
- 2years full warranty in most applications
- Longer Service Life, in both Float or Cycling applications
- High Power Density

APPLICATIONS

- Off-grid solar systems
- RV and marine
- UPS/Telecom
- Electric vehicle
- Golf cart

DIMENSIONS & WEIGHT

Length(mm)/inches	307±1 /12.08
Width(mm)/inches	169±1/6.65
Height(mm)/inches	211±1/8.31
Total Height(mm)/inches	216±1/8.5
Weight(kg)/lbt	30.2±3%/67.24

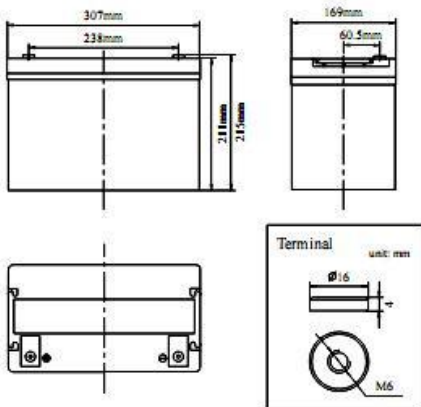

TECHNICAL SPECIFICATIONS

Nominal Voltage		12V(6 cells per unit)
Design Floating Life @25°C		15 Years
Nominal Capacity @25°C (20 hour rate@5.0A,10.8V)		100Ah
Capacity @25°C	10hour rate (9.0A,10.8V)	90Ah
	5 hour rate (15.9A,10.5V)	79.5Ah
	1 hour rate (55.6A,9.6V)	55.6Ah
Internal Resistance	Full Charged Battery@25°C	≤6.0mΩ
Ambient Temperature	Discharge	-15°C~45°C
	Charge	-15°C~45°C
	Storage	-15°C~45°C
Max.Discharge Current@25°C		540A(5s)
Capacity affected by Temperature (10 hour)	40°C	105%
	25°C	100%
	0°C	85%
	-15°C	65%
Self-Discharge@25°C per Month		3%
Charge (Constant Voltage) @25°C	Standby Use	Initial Charging Current Less than 25A Voltage 13.6-13.8V
	Cycle Use	Initial Charging Current Less than 25A Voltage 14.4-14.9V

BATTERY DISCHARGE TABEL

Discharge Constant Current per Cell (Amperes at 25°C)

F.V/Time	15min	30min	45min	1h	2h	3h	5h	8h	10h	20h	100h
1.60V	128.7	82.0	60.5	55.6	35.3	24.8	16.8	11.1	9.9	5.4	1.20
1.65V	126.4	80.5	59.4	54.5	34.6	24.3	16.5	10.9	9.7	5.3	1.18
1.70V	124.0	79.0	58.3	53.5	34.0	23.9	16.2	10.7	9.5	5.2	1.15
1.75V	121.7	77.5	57.2	52.5	33.3	23.4	15.9	10.5	9.4	5.1	1.13
1.80V	117.0	74.5	55.0	50.5	32.1	22.5	15.3	10.1	9.0	5.0	1.11

Discharge Constant Power per Cell (Watts at 25°C)

F.V/Time	15min	30min	45min	1h	2h	3h	5h	8h	10h	20h	100h
1.60V	247.7	157.8	116.5	106.9	67.9	47.6	32.4	21.4	19.1	10.4	2.31
1.65V	243.2	154.9	114.3	105.0	66.6	46.8	31.8	21.0	18.7	10.2	2.26
1.70V	238.7	152.0	112.2	103.0	65.4	45.9	31.2	20.6	18.4	10.0	2.22
1.75V	234.2	149.1	110.1	101.1	64.2	45.0	30.6	20.2	18.0	9.8	2.18
1.80V	225.2	143.4	105.9	97.2	61.7	43.3	29.5	19.4	17.3	9.6	2.14

Note: The above data is based on average values and can typically be achieved within 3 charge/discharge cycles. Battery designs and specifications are subject to change without notice. Contact Valiant for the latest information.

Deep Cycle VRLA AGM Battery

VTD12-100

PERFORMANCE CHARACTERISTICS

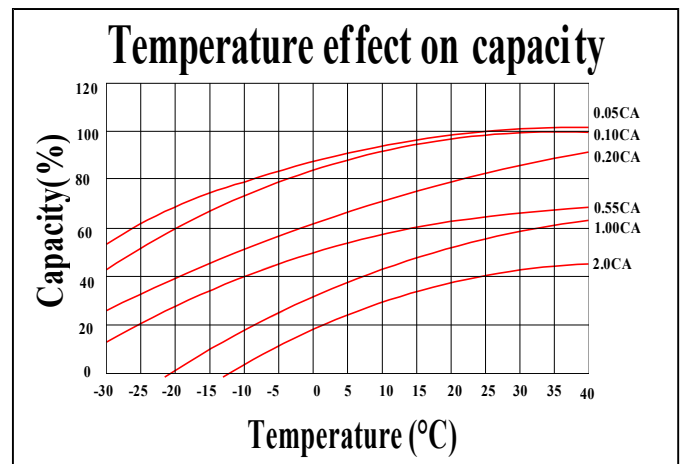
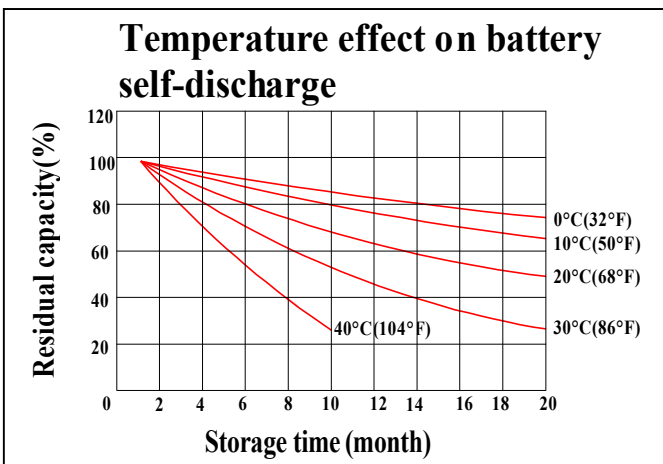
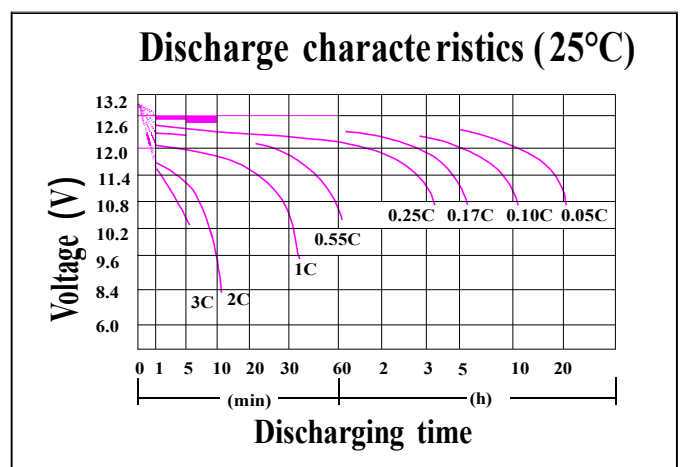
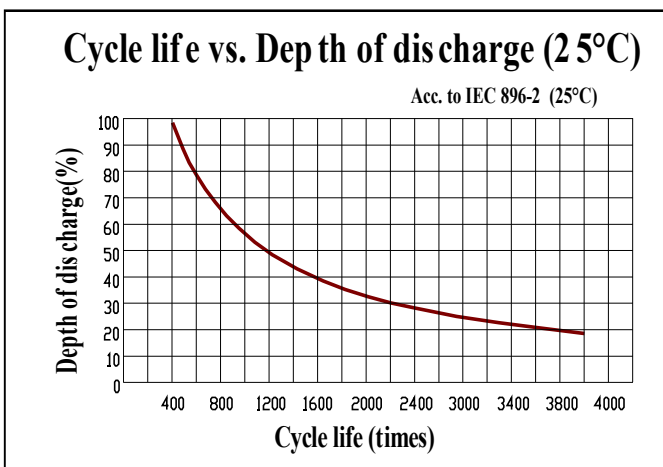
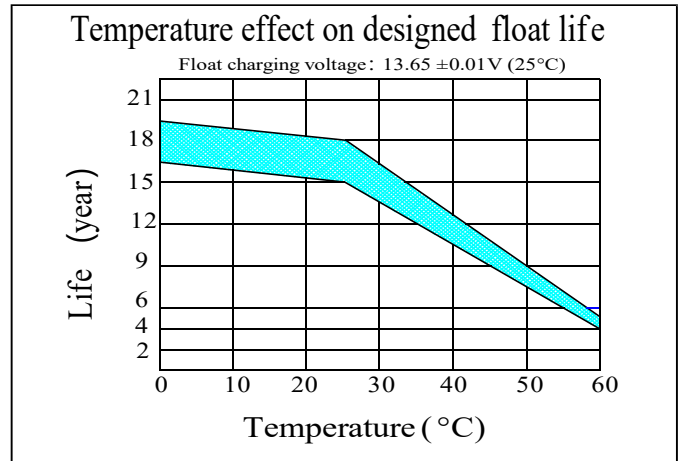
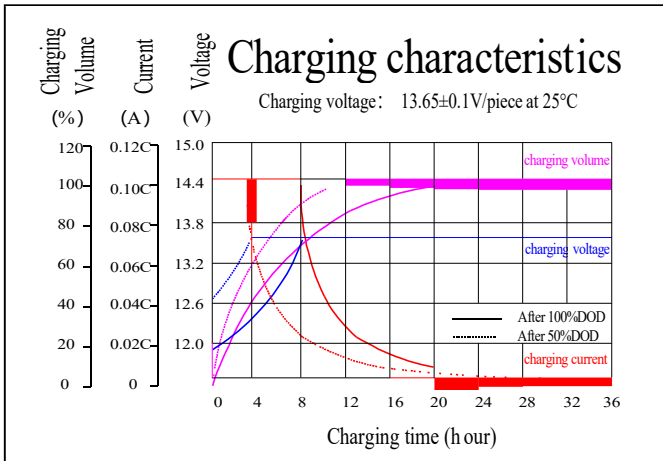

BATTERY CONSTRUCTION

Component	Positive plate	Negative plate	Container & Cover	Safety valve	Terminal	Separator	Electrolyte	Pillar seal
Features	Thick high Sn low Ca grid with special paste	Balanced Pb-Ca grid for improved recombination efficiency	Fire resistance ABS UL94-V0	Flame Si-Rubber and aging resistor	Female Copper Insert M6(torque: 4~6N.m)	Advanced AGM separator for high pressure cell design	Dilute high purity sulphuric acid	Two layers epoxy resin seal